

Overview of University of the Wisconsin IEC Research Program-2011

G. L. Kulcinski, J. F. Santarius, G. A. Emmert,
R. L. Bonomo, E. C. Alderson, G. E. Becerra,
L. M. Garrison, K. B. Hall, A. M. McEvoy, M. K.
Michalak, and C. M. Schuff

Produced by University Communications

December 7-8, 2011
13th U.S.-Japan IEC Workshop





Overview



- Progress since the 12th Meeting in Osaka, 2010.
- Specific Highlights on Selected Projects.
- Conclusions & Future Work



The Wisconsin IEC Team





Other UW-IEC Papers at the 2011 U. S./Japan Workshop



(Presenting Author/Title/Time)

- Matt Michalak, **“Six Ion Gun Fusion Experiment Findings and Future Work”**
Wed. 2:00 PM.
- Gabriel Becerra, **“Enhancement of an Inertial Electrostatic Confinement Device with a Helicon Ion Source for Helium-3 Fusion”**, Wed. 2:30 PM.
- Rich Bonomo, **“UW IEC Group 2011: Continuing Preparations for 300 kV Operation – Device Switching”**, Wed. 3:00 PM.
- Gil Emmert, **“Update on the VICTER Code for Modeling Gridded, Spherically Symmetric IEC Devices”**, Thurs. 9:00 AM.
- Eric Alderson, **“Negative Ion Studies in an IEC Fusion Device”**, Thurs 9:30 AM.
- John Santarius, **“Theoretical Exploration of UW IEC Device Operation at Moderate Pressure”**, Thurs. 10:00 AM.



Current IEC Research Projects at the University of Wisconsin

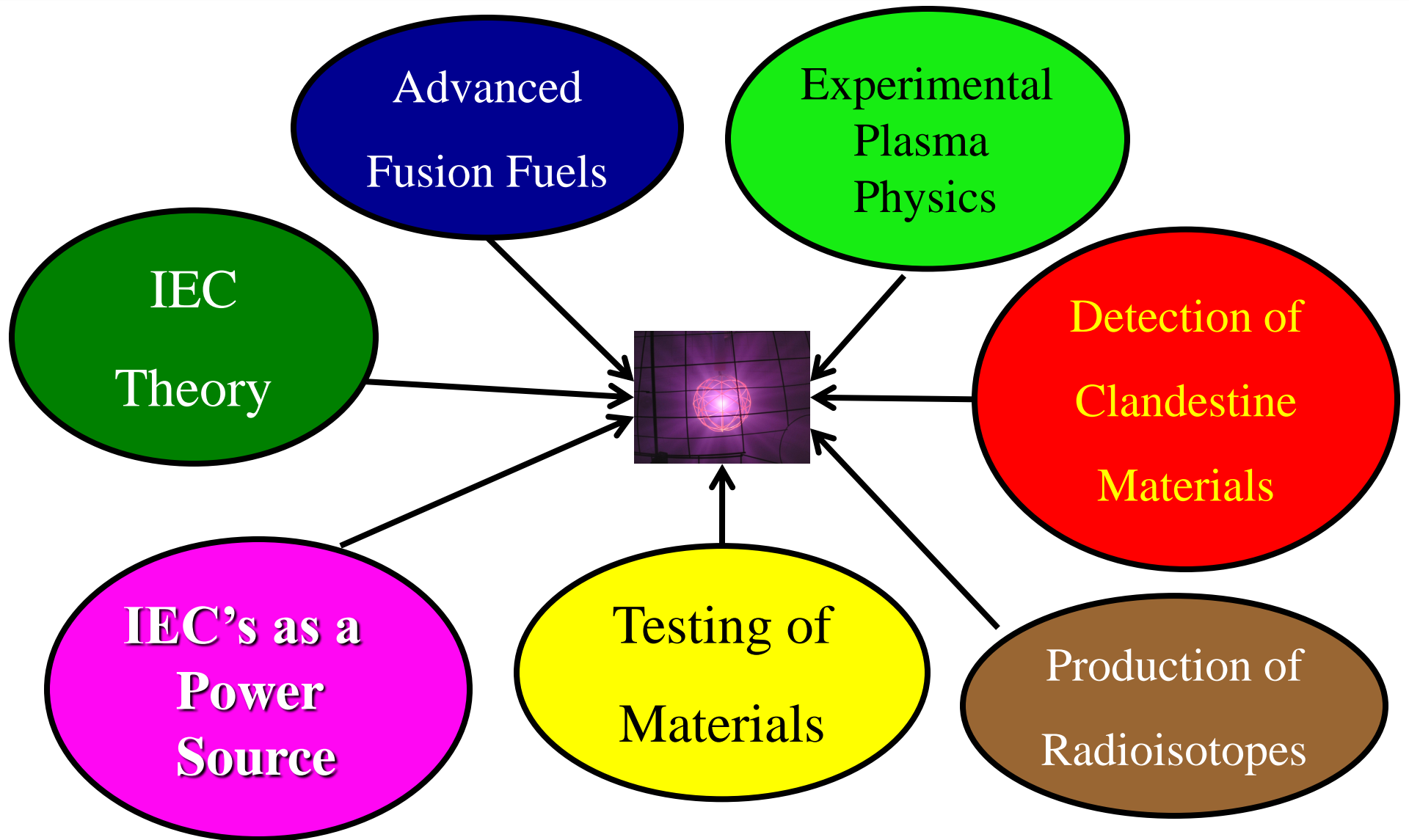



There are Currently Four Different “IEC” Chambers in Operation and One Under Construction at the University of Wisconsin



HOMER

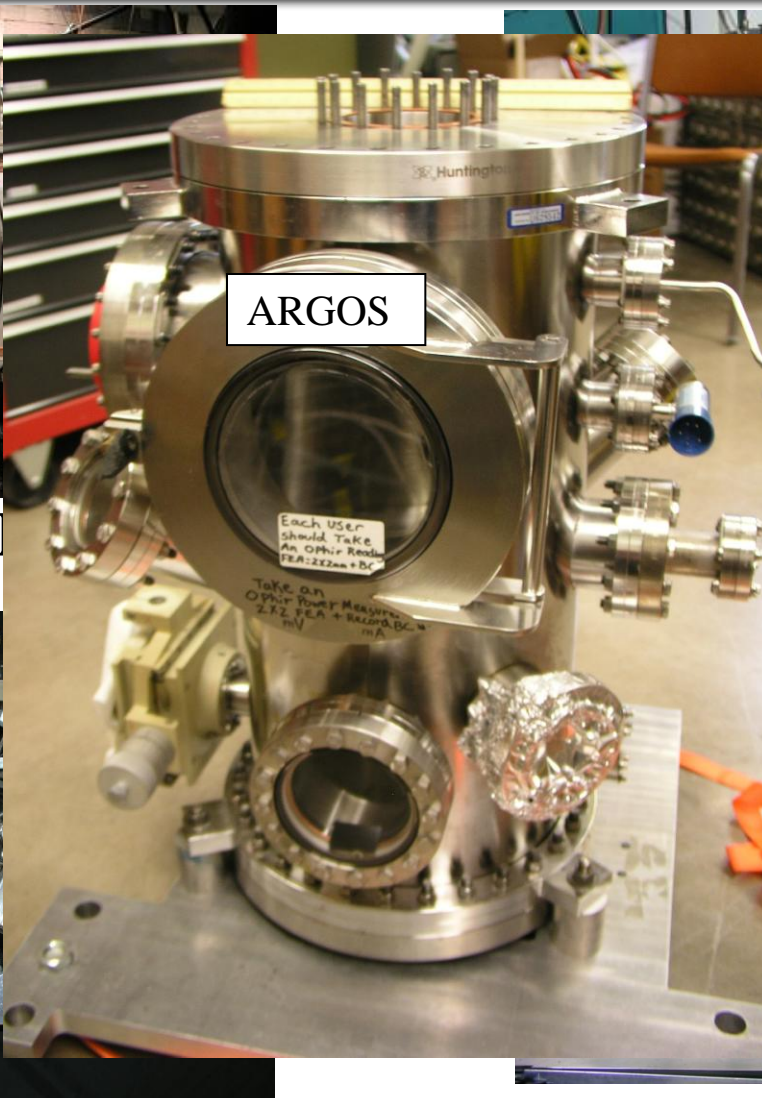

ARGOS

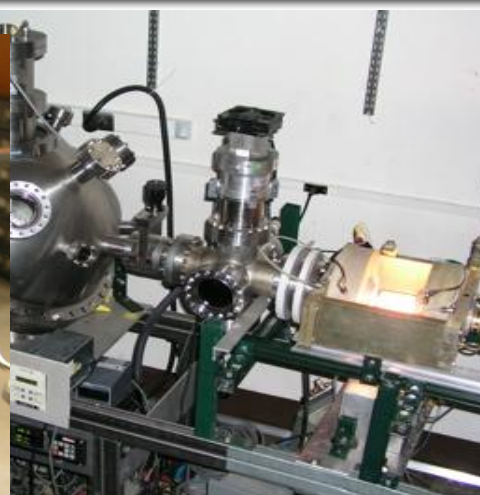

HELIOS

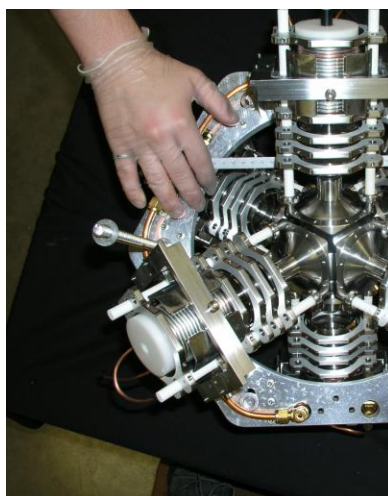

SIGFE



MITE-E

Progress at UW IEC Facilities Since the Last Meeting in Osaka

Negative Ions in Jets

PING Facility (ARGOS Chamber)

2012

VICTER Code Includes Negative Ions



13th@ Sydney

300 kV Switch Developed

Adjustable TOF Diagnostic

2011

Discovery of W “grass”



12th@ Osaka

2010



Development of Improved Pulsed Neutron Sources is Progressing



- Storoid Facility:
 - patent application
 - results next Workshop
- PING Facility
 - Concept developed-2010
 - ARGOS chamber constructed-2011
 - Tests in 2012



The ARGOS Chamber





The *MITE-E's* Ion Gun Module

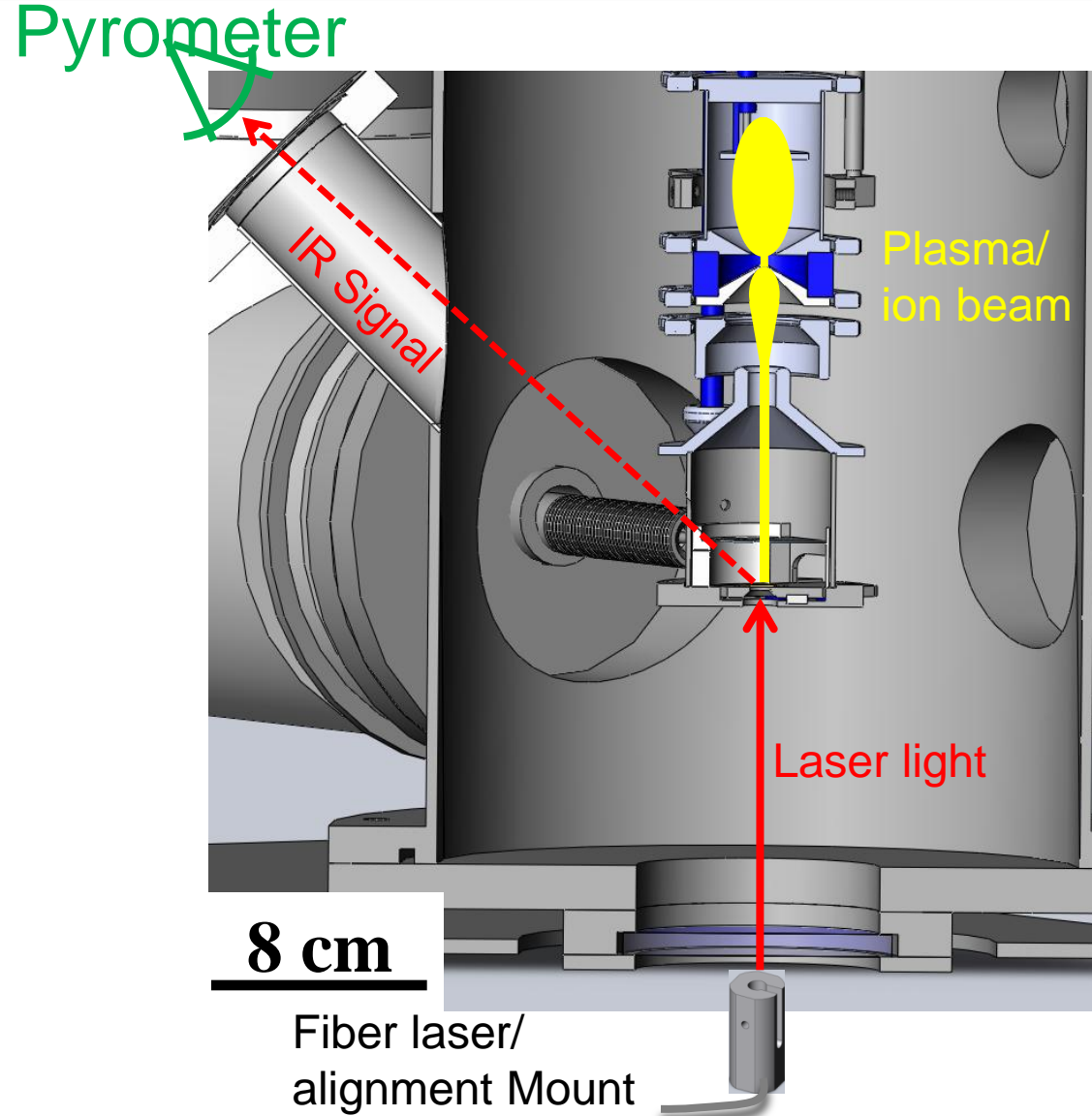
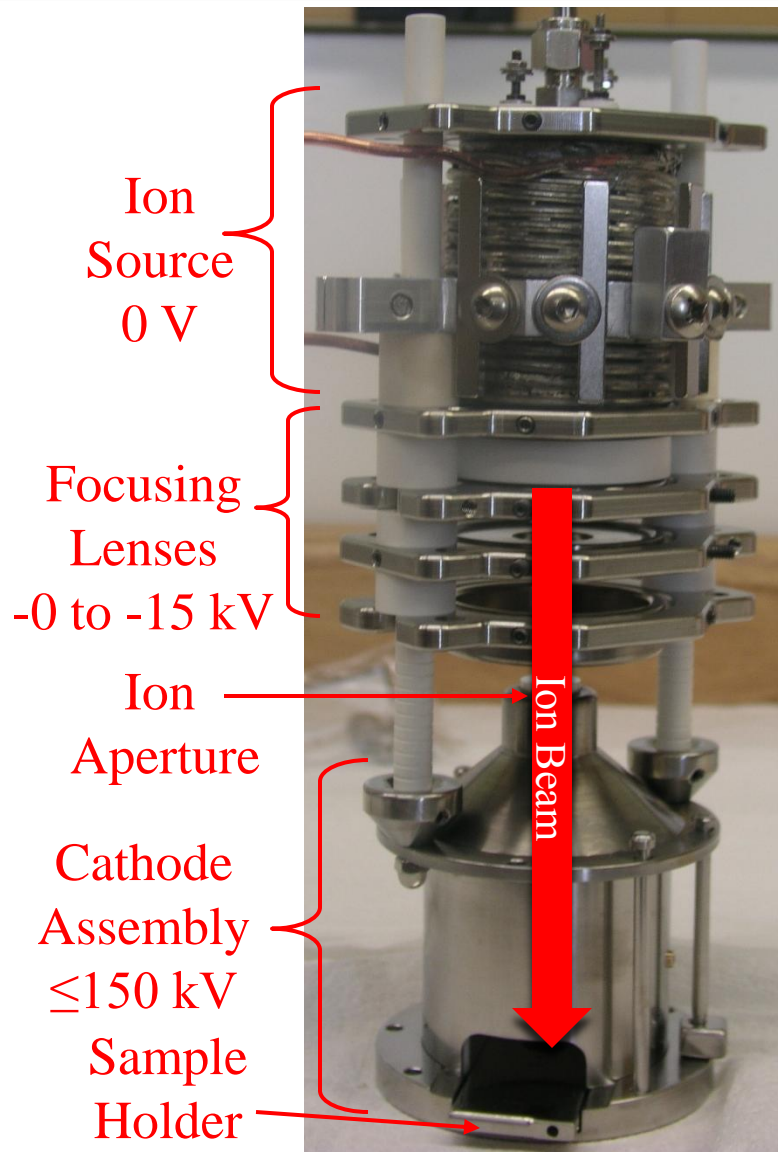

In the *MITE-E*, Surface Morphology Changes for W are Highly Dependent on Crystal Orientation

Highly Sputtered Grains

Moderately Sputtered Grains

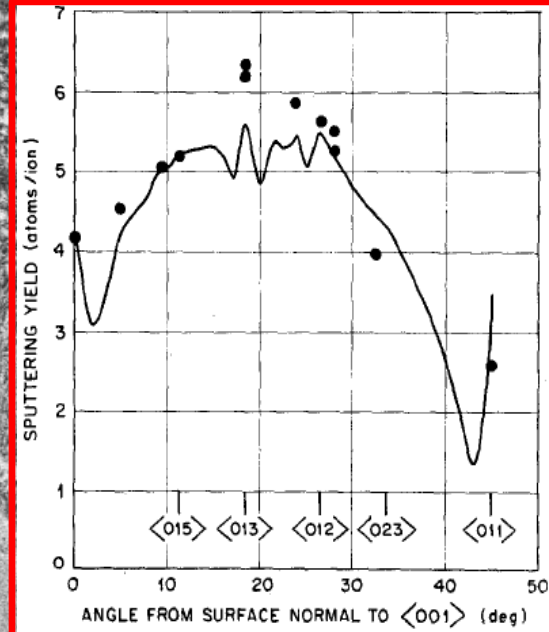

Southern, et al.

2 μm

$\phi_L \sim 1.5 \times 10^{19}$
 $T \sim 700^\circ\text{C}$



“Grass” Morphology Dependent on the Orientation of the Grains

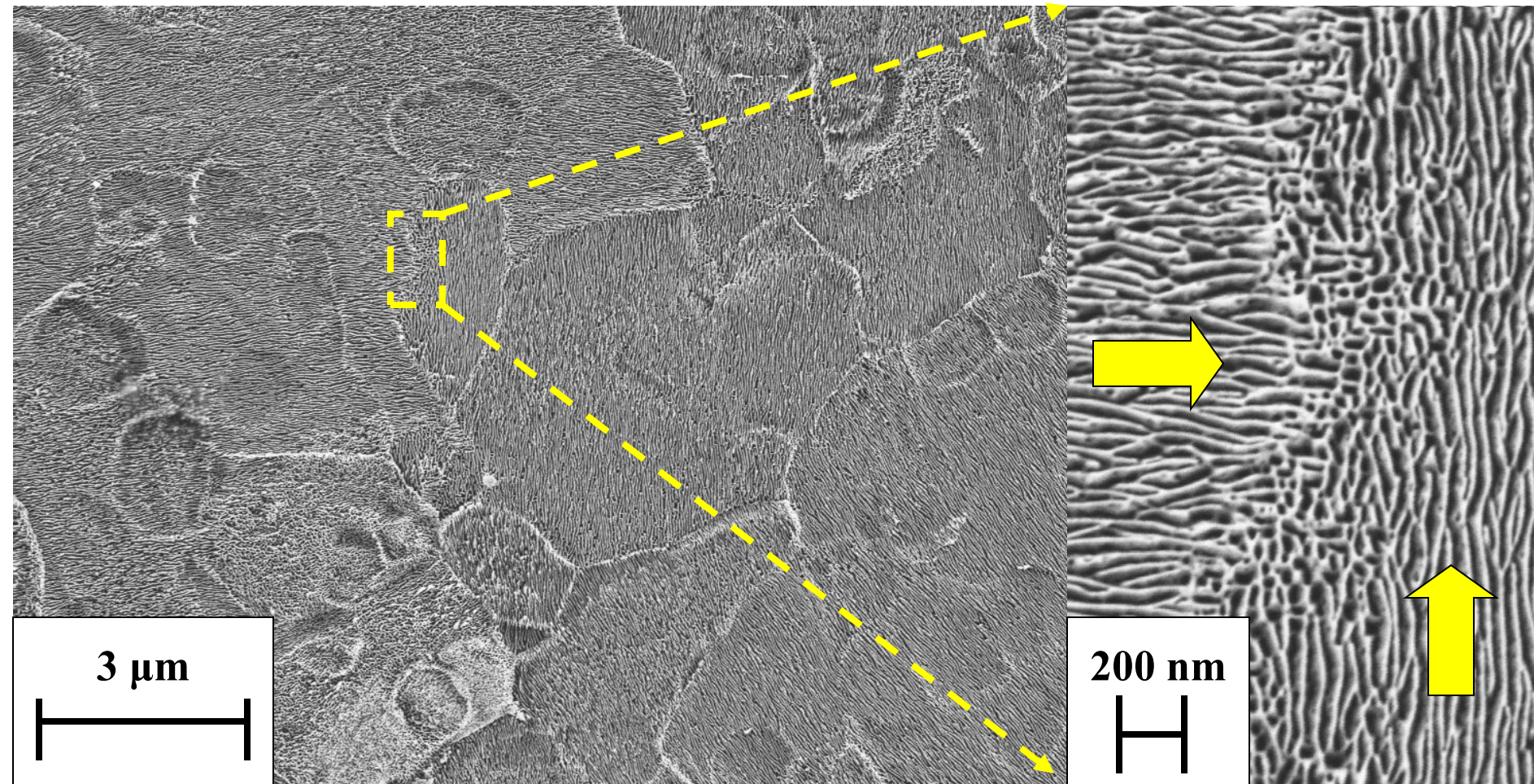

$\phi_L - 1.3 \times 10^{18} \text{ He}^+/\text{cm}^2, T - 900^\circ \text{ C}$

Fusion Ion Doppler (FIDO) Diagnostic Was Developed by Boris to Reduce Background Noise During D-D Proton Collection

- **Detector face moved out of line of sight of chamber**
- **Magnetic Deflection**
 - **Fusion products (MeV)**
 - **Secondary electrons (Hundreds of keV)**

- **Pb shielding around collimator channel and detector mount**

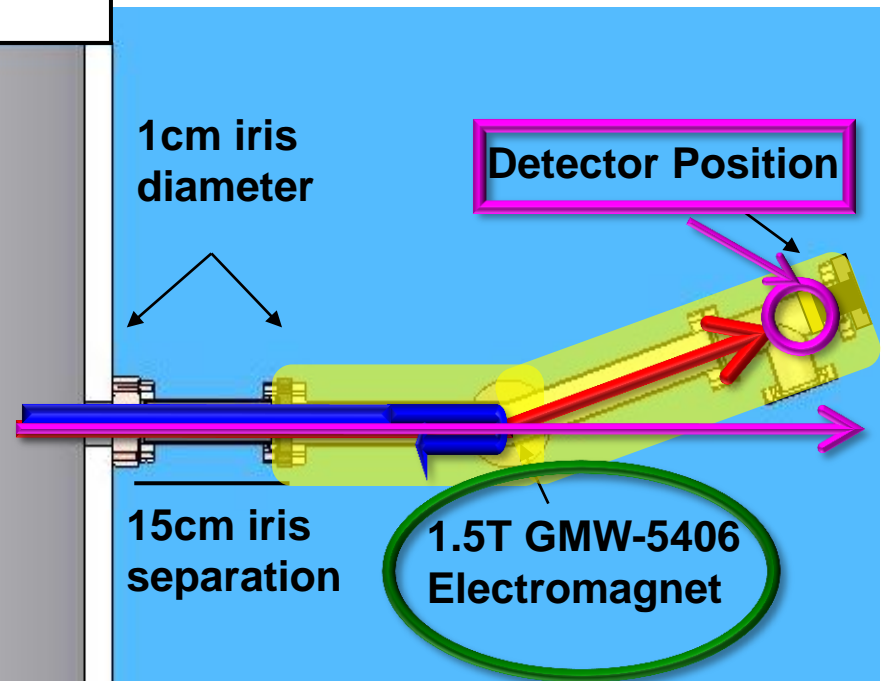
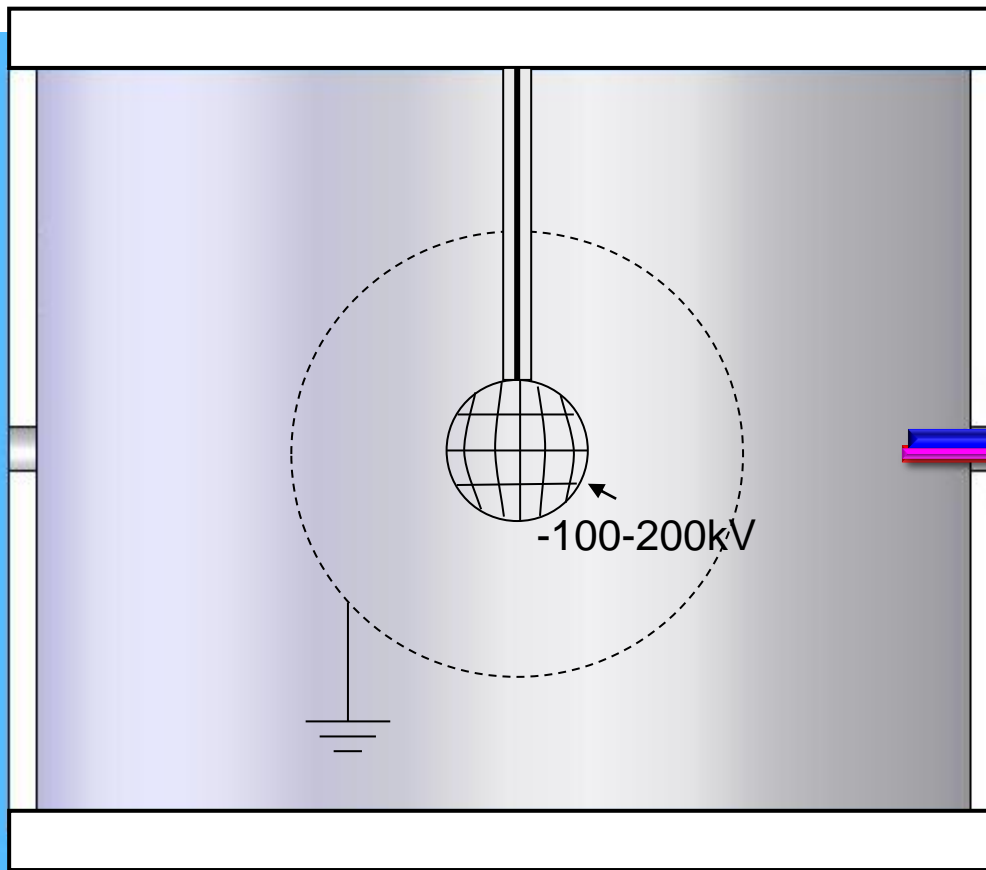



Bending Arm Allows Both Protons and Tritons to be Detected Along with Doppler Shifts



Raw Data from Charged Particle Detector (60kV 45mA 1.5mtorr)

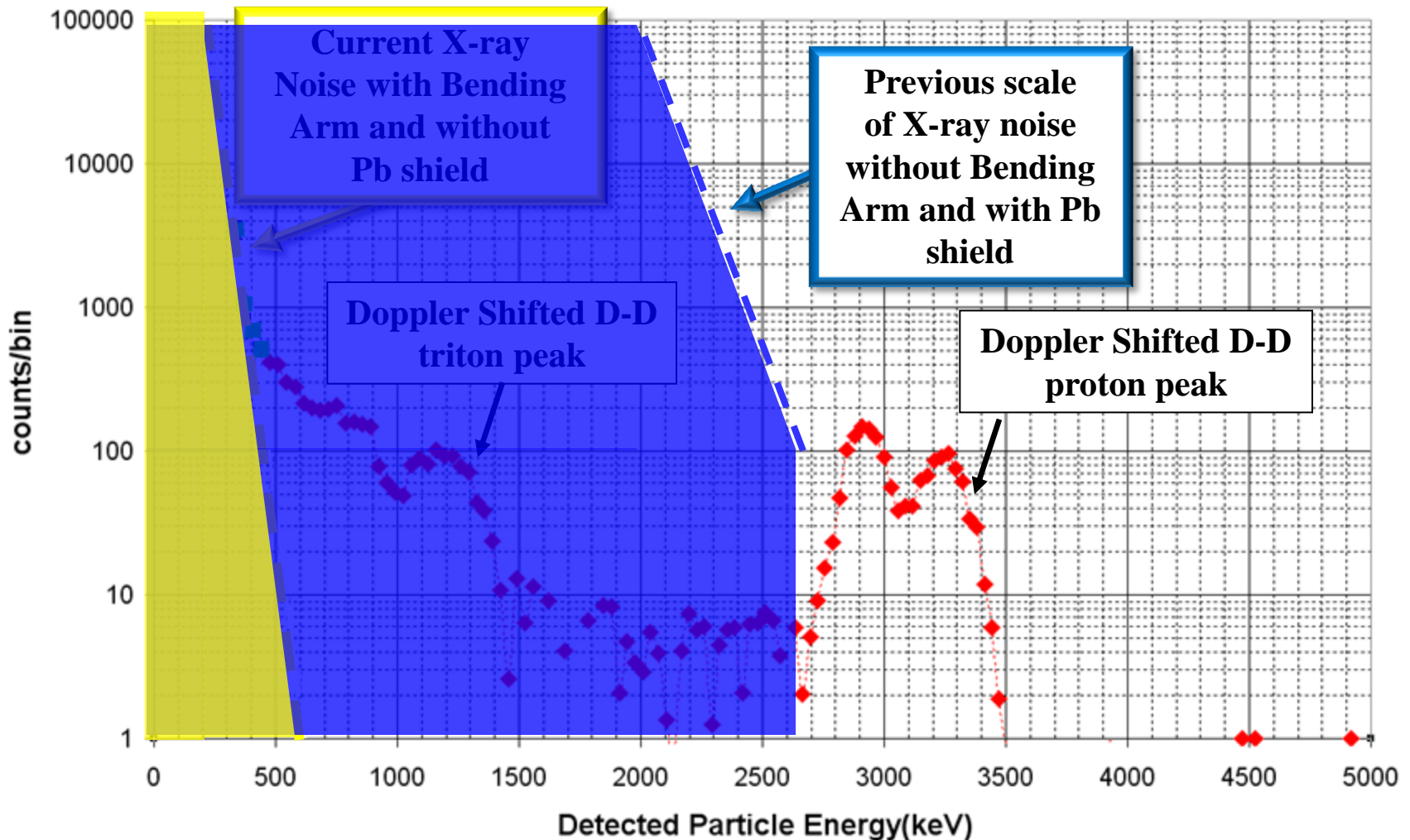



Spatial Profile of Fusion Reactions per Unit Volume Along Radial Line Through IEC (Donovan)



TOF Spatial Profile Along Radial Chord - Shown from (-R) to (+R)
60kV, 30mA, 2mTorr, 20cm Diameter Cathode, 50cm Diameter Anode

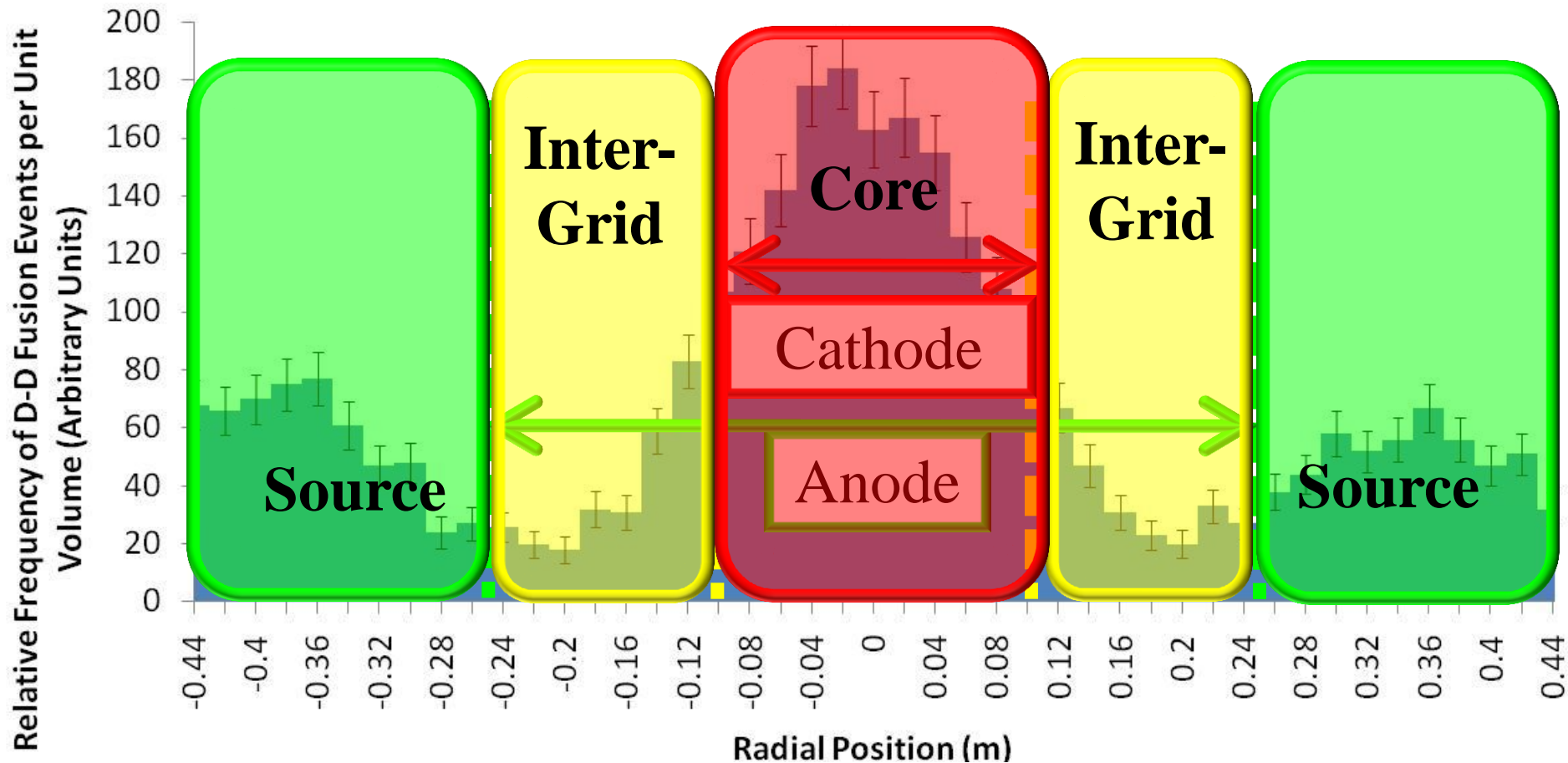

■ Plot extends from chamber wall (-R) to chamber wall (+R) 15



TOF Radial Profile Shows a Rise in Fusion Event Concentration in the Source Region (Donovan)



TOF Radial Profile - 60kV - 30mA - 2mTorr Deuterium
20 cm Diameter Cathode - 50 cm Diameter Anode

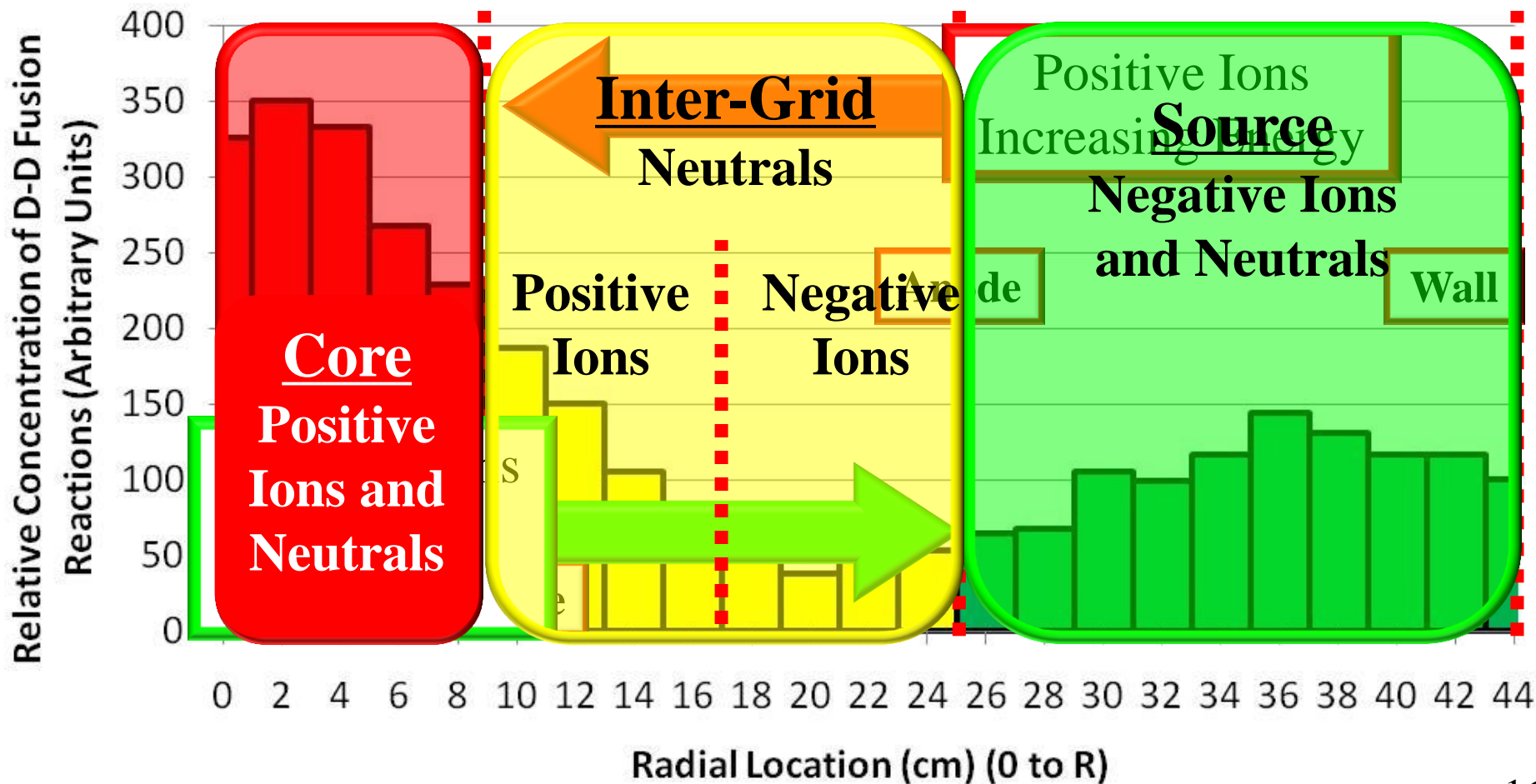



An Adjustable Diagnostic Arm Has Been Successfully Constructed and Tested

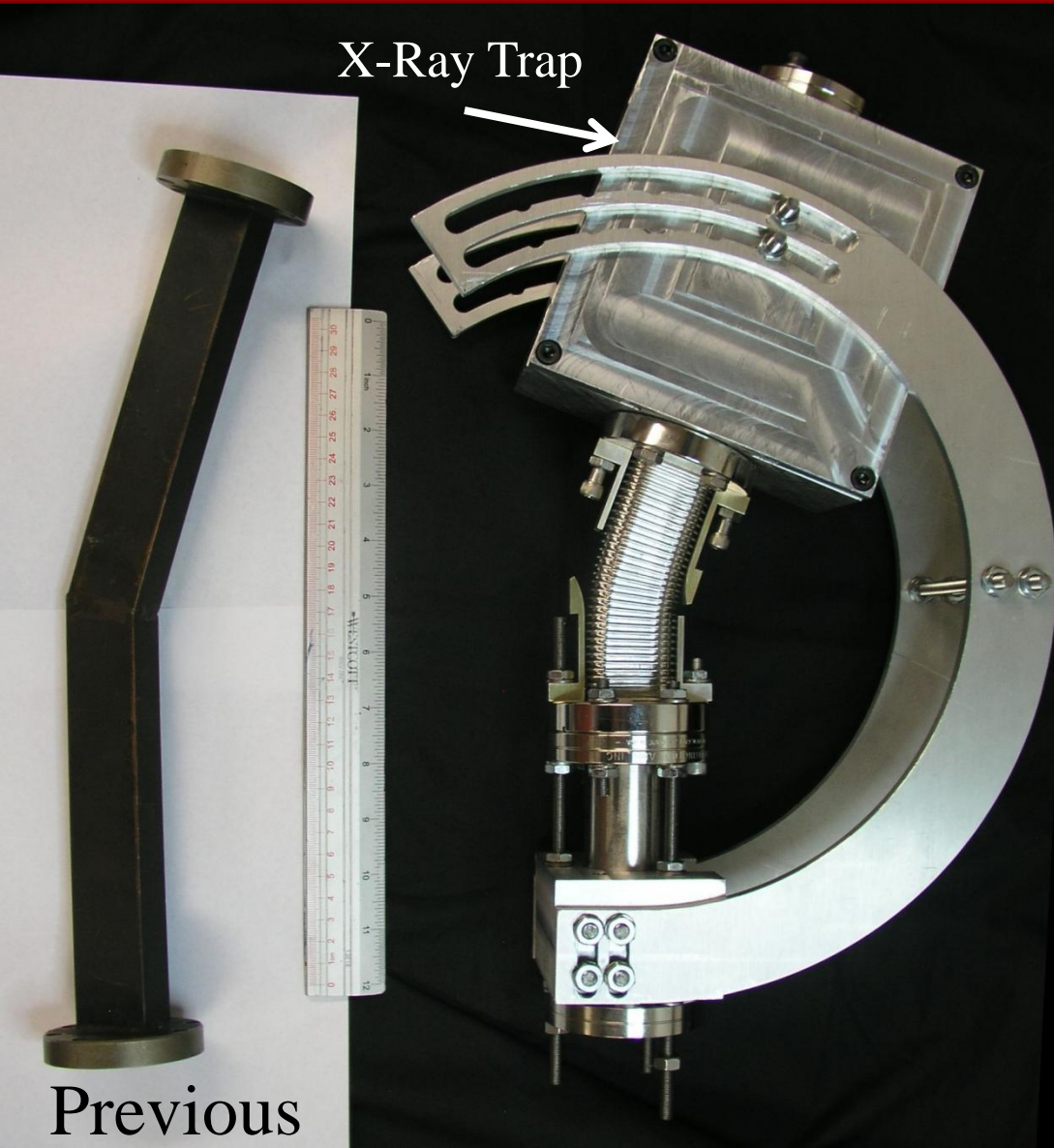

- Capable of reaching at least $1 \mu\text{Torr}$
- Able to study:
 - D-D Fusion (20°)
 - D-He³ Fusion (15°)
 - Negative Ions (-20°)
- Adjustable rectangular 316 SS bellows arm allows 66 times greater D-D proton capture ability at higher power due to noise reduction
 - X-ray trap and corrugated elbow offer factor of 5 increase in proton collection
 - Increasing angle from 20 to 30 degrees further increases proton capture by factor of 13

Previous



Conclusions



- Considerable progress has been made in experimental facilities
 - Adjustable Arm for FIDO and TOF measurements
 - Argos chamber for pulsed neutron generation
 - 300 kV switch for rapid changeover of 4 IEC devices
 - New design for 300 kV feed-through to avoid insulating stalk failures
- IEC Technology spinoff has been used for a materials irradiation facility



Conclusions (cont.)



- Negative ion azimuthal scans reveal structure in “jets”.
- Negative ions seem to be playing an unexpected role in promoting DD fusion in IEC devices.
- Helicon optimization studies improve performance
- VICTER code now has the ability to include negative ions and their transport in IEC devices.
- Six gun ion experiments reveal more about plasma physics of Hirsch device.



Future Goals of UW IEC Program



- Understand the role of negative ions in the spatial distribution of DD fusion events.
- Apply the TOF adjustable arm diagnostic to D^3He fusion.
- Test plasma facing component materials at higher temperatures and a wider range of fluences.
- Investigate D^3He fusion in 6-Gun SIGFE device.
- Analyze test results from STOROID and PING pulsed neutron facilities.



Future Goals of UW IEC Program (cont.)



- Compare VICTER theoretical predictions with experimental data from HOMER.
- Increase the He^+ source strength of HELIOS.
- Test pulsing effects on SIGFE.

Questions?

