

Study on Upgrades of the Magnetron Ion Source for High Current Operation of the Low Pressure IEC Device

US-Japan IEC Workshop 2011

Dec. 7-8, Sydney

T. Kajiwara, Y. Kamiya, K. Masuda, Y. Yamagaki,
G. Hashimoto and K. Nagasaki
Institute of Advanced Energy, Kyoto Univ., Japan

Outlines

- Introduction for the Ring-Shaped Magnetron Ion Source (RS-MIS) driven IEC
- Upgrade plan of RS-MIS
- Studies for the upgrade
 - Trajectory simulation.
 - Preliminary experiments on electron emitters.
- Conclusions

Concepts of the RS-MIS IEC

Beam-gas ... limited by $\sigma_{\text{fusion}}/\sigma_{\text{CX}}$

Beam-beam ... maybe promising, but still not clear.

Observation of beam-beam reactions and making its physics clear.

- High ratio of I_{IEC}/P with the aid of the RS-MIS.
- Planar convergence of ions.
- Ion production in the negative potential area.

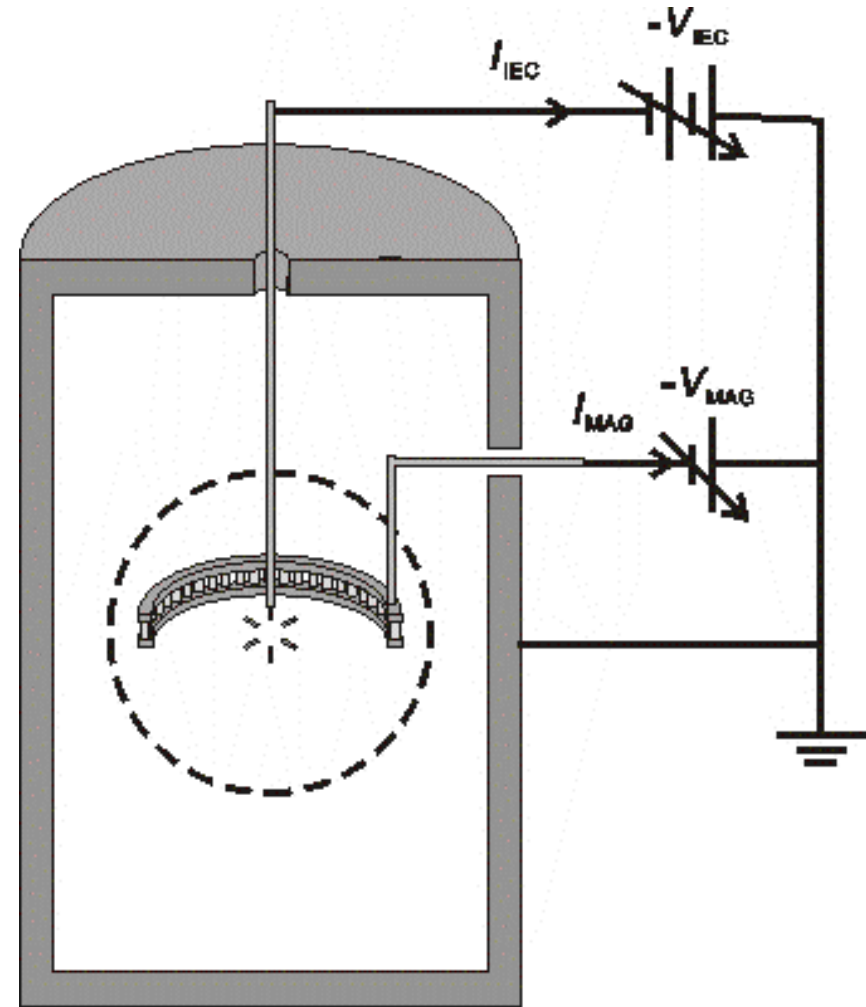

Setup of the RS-MIS IEC

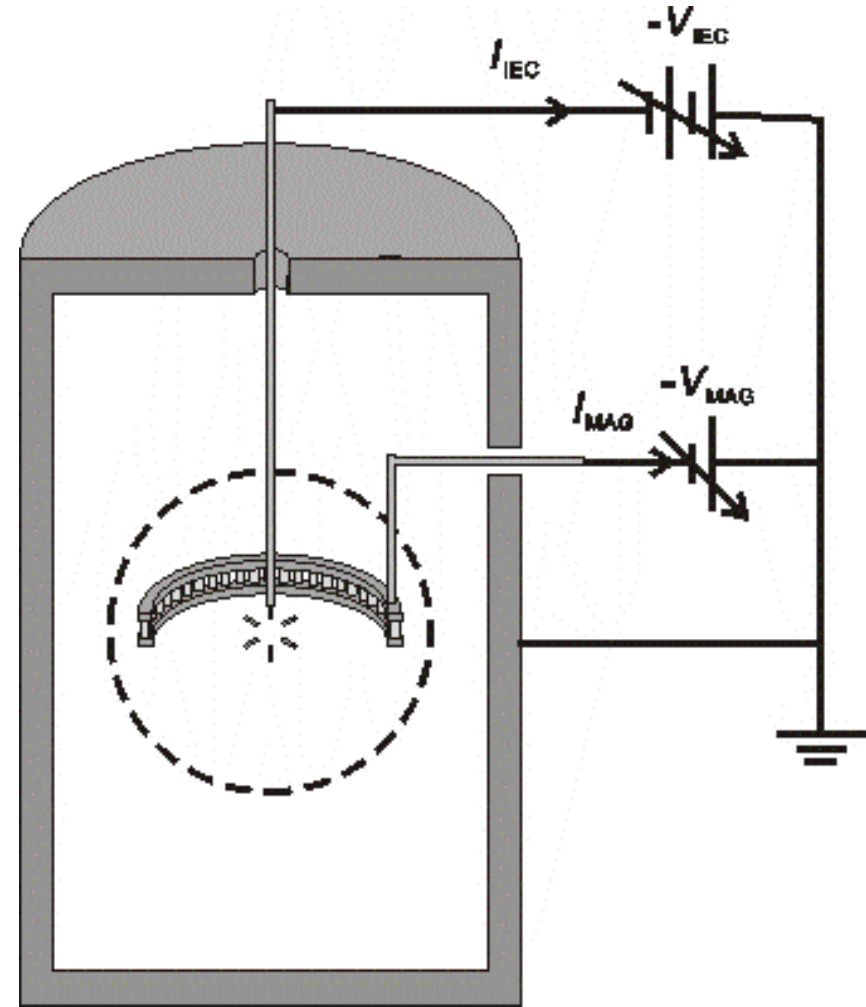
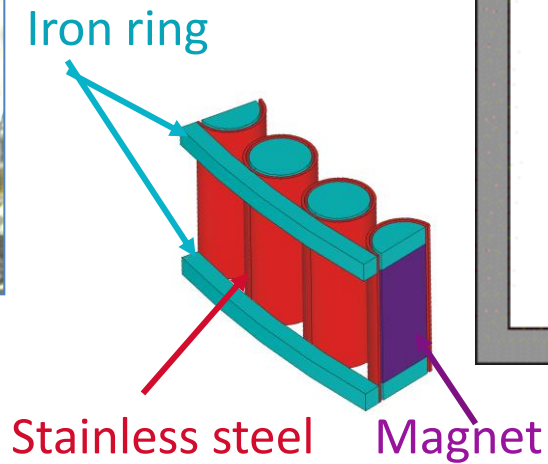
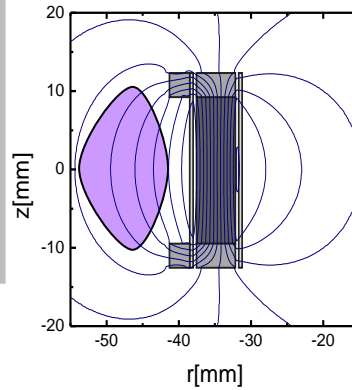
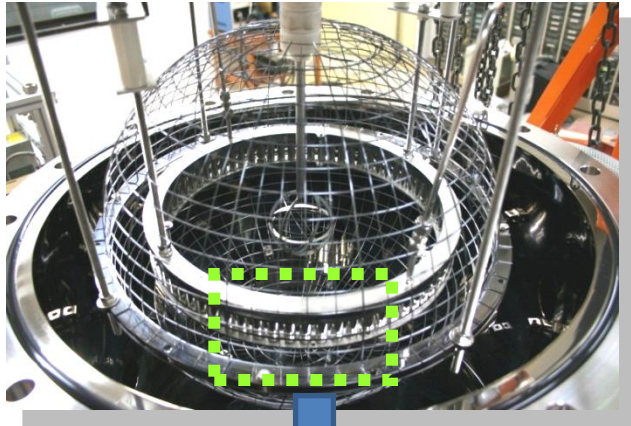

Operating modes of the RS-MIS IEC

High pressure mode (Glow mode):

- $V_{\text{MAG}} = \text{grounded}$.
- Typically 0.1-5Pa.
- Similar to a conventional glow driven IEC w/o RS-MIS.

Low pressure mode (RS-MIS mode):

- $V_{\text{MAG}} = \sim -10\text{kV}$
- Units of mPa.

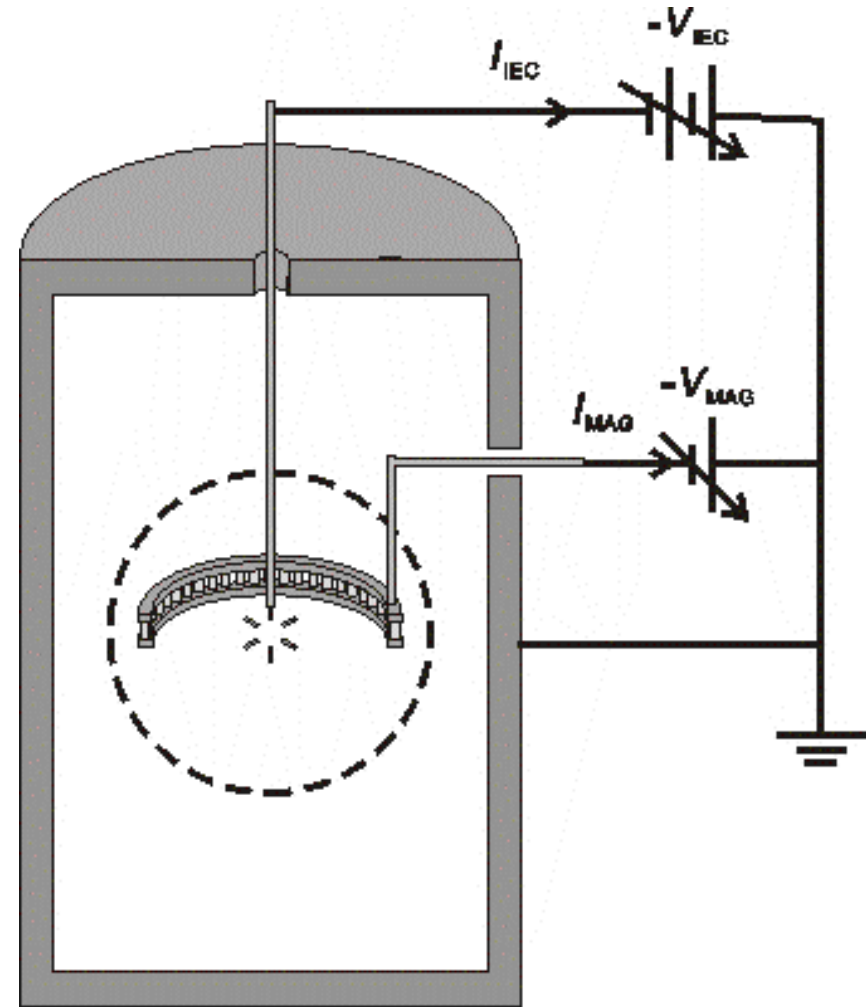

Comparison of NPR between the two modes

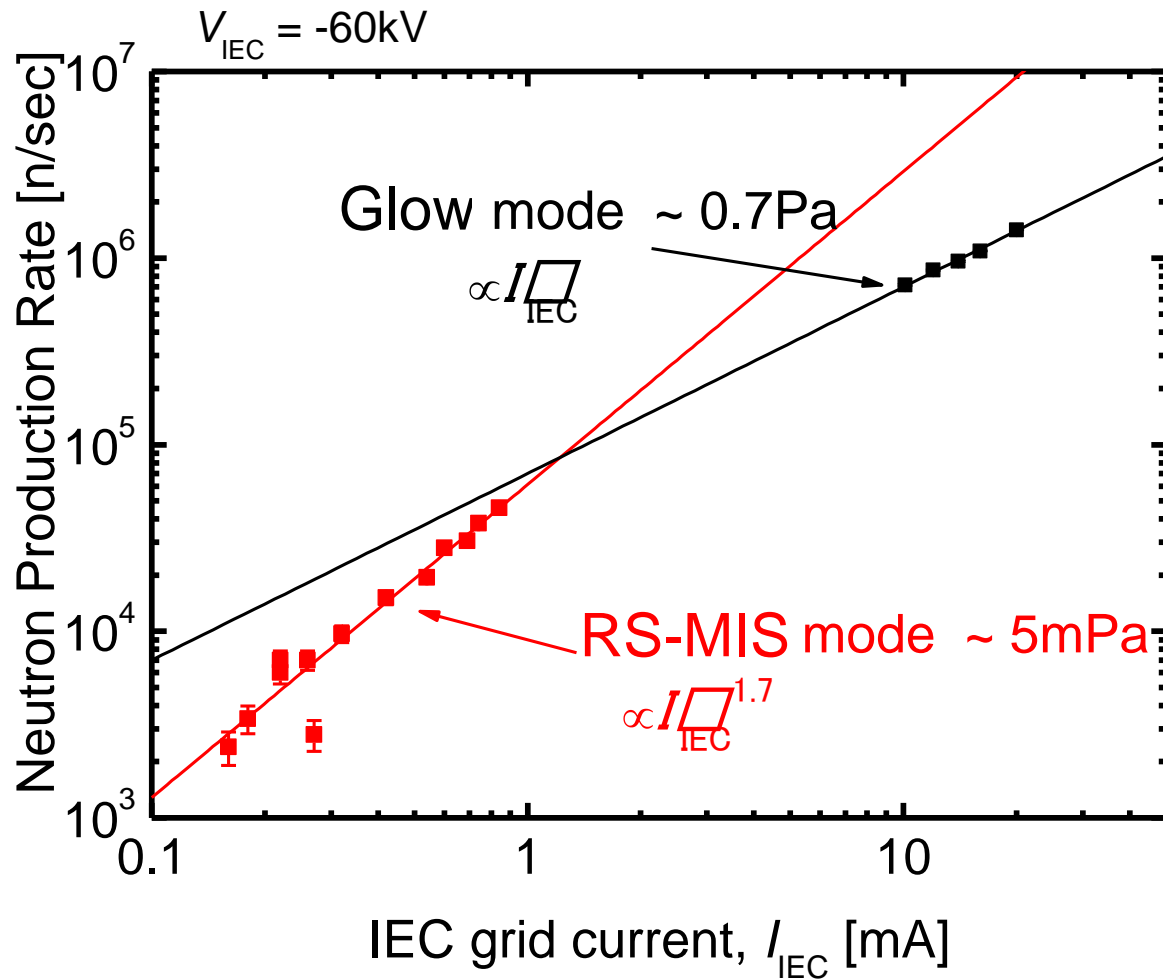

Operational currents are quite different, so far.

Objective

In order to understand the physics in RS-MIS mode, we want to expand operating conditions of the RS-MIS IEC.

Upgrade of the RS-MIS for high current operation ($\sim 1\text{A}$ @ 5mPa) is necessary.

Theory of magnetron discharge

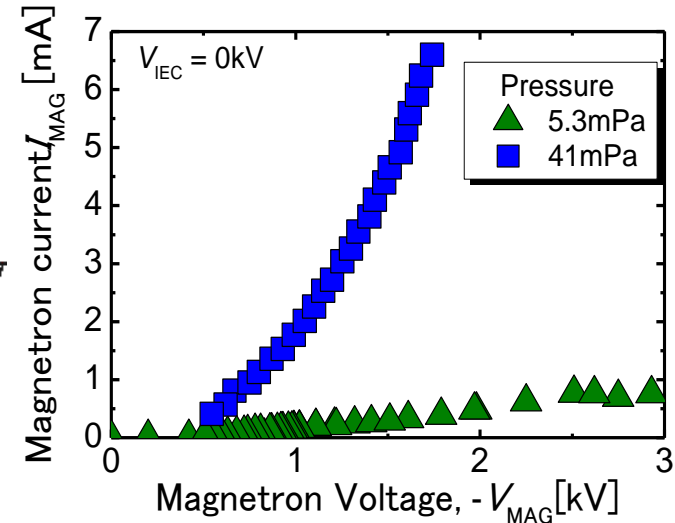
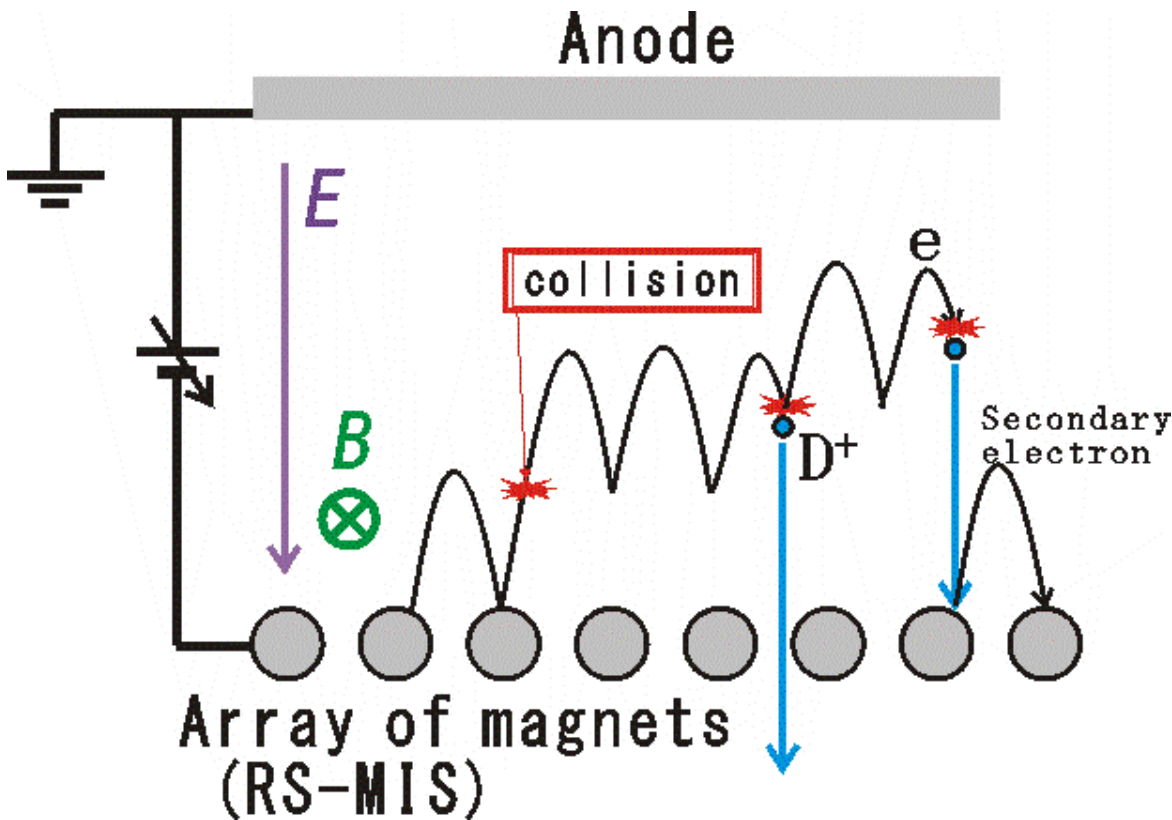

- No current flowing into the RS-MIS without electron collisions with neutral molecules.
- The ionization and electron emission (thermal + secondary) balance in a specific steady state.
- Resultant ion current should be decided by electron current emitted from the RS-MIS.

Theory of magnetron discharge

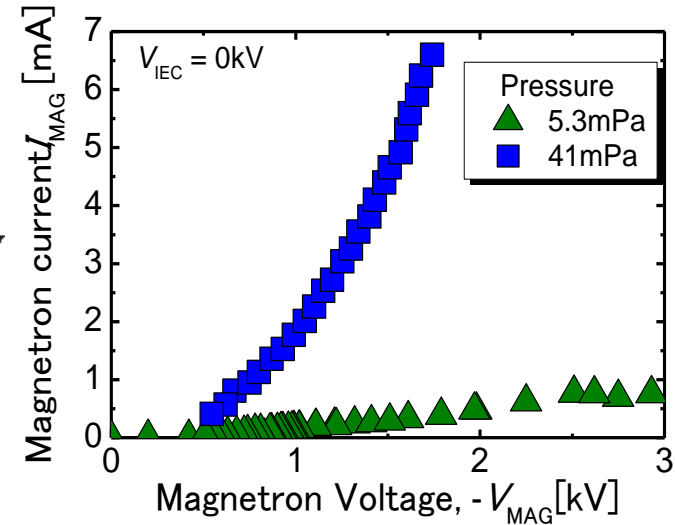
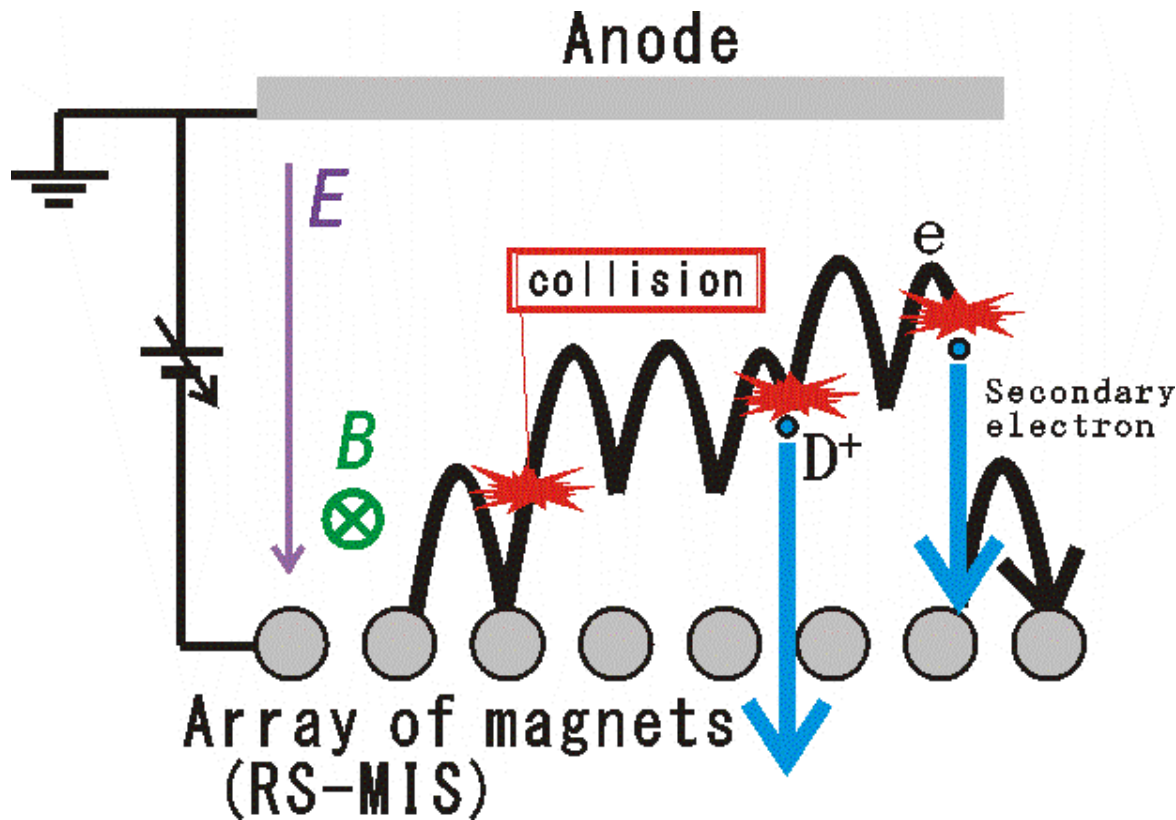

- No current flowing into the RS-MIS without electron collisions with neutral molecules.
- The ionization and electron emission (thermal + secondary) balance in a specific steady state.
- Resultant ion current should be decided by electron current emitted from the RS-MIS.

Method and issues for high current operation

Method:

Installation of **thermionic electron emitters** on the RS-MIS instead of some of magnets.

Issues:

- ✓ Choice of emitters
- ✓ Confinement of electrons
- ✓ Space-charge limit effect

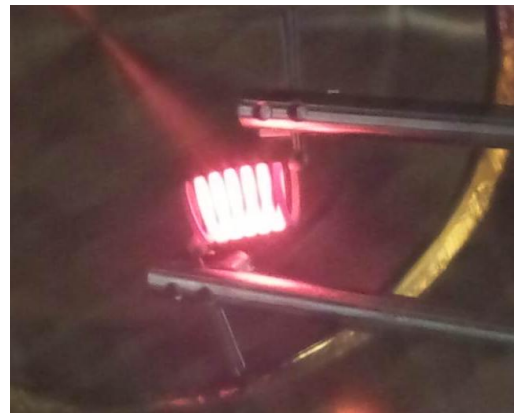
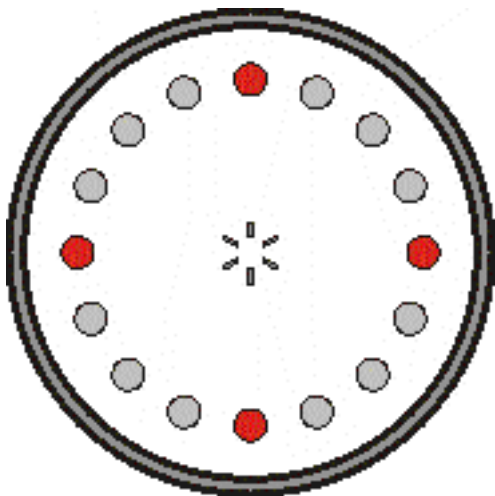
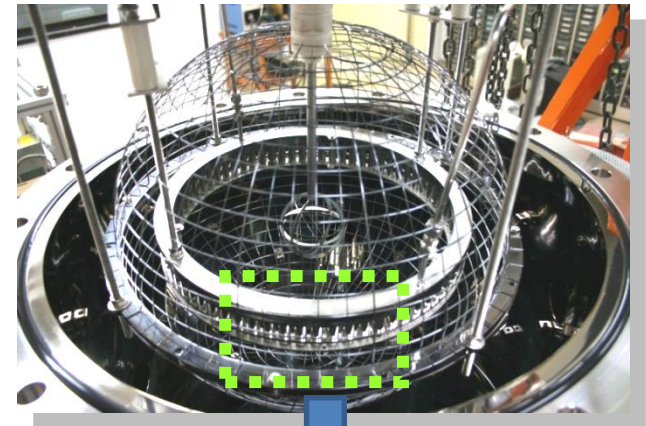

Assumptions of simulation

- 2-D configuration. Array of magnets of RS-MIS is replaced with a cylindrical magnet.
- No ions can be extracted into the central cathode because of no spacing between magnets.
- Incident electron current (thermal + secondary) emitted from the RS-MIS surface is given as input.

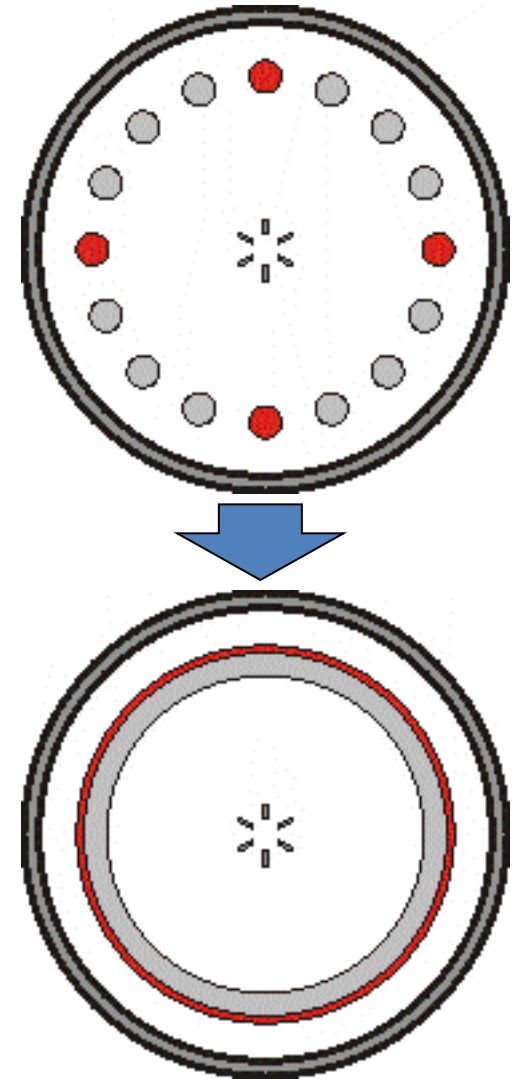

Configuration of simulation

Blue lines: Equi-potential lines
Red lines: Magnetic flux lines

He gas @5mPa

Electron
emission
surface

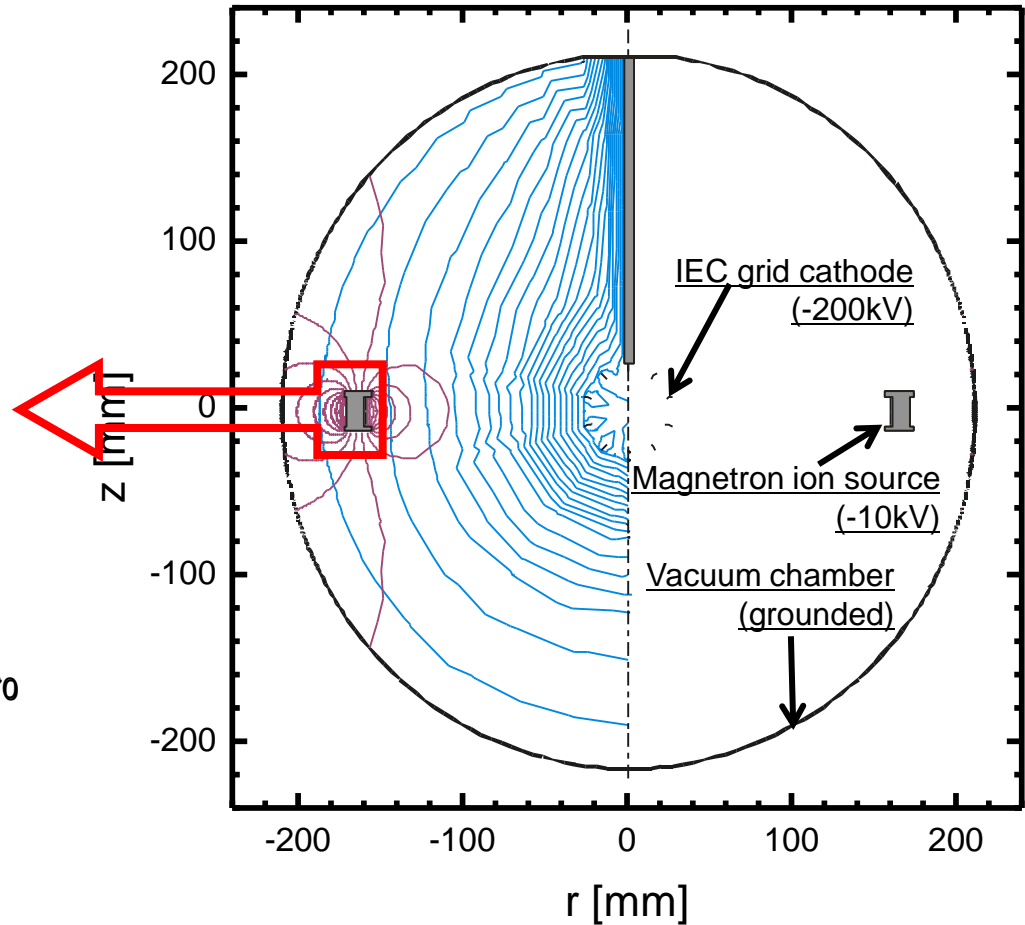
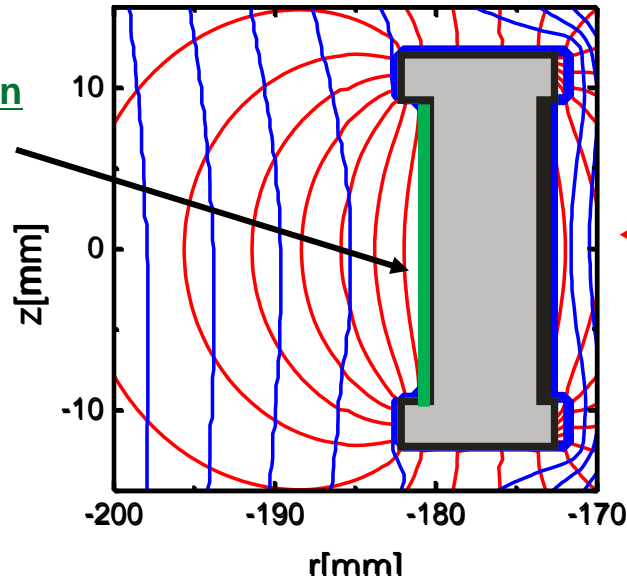

Characteristics of the code called 'ku-code'

- 2-D
- Particle-in-cell based on the Finite Element Method
- Taking into account the space-charge effect
- Handling atomic and molecular collision

K. Masuda and K. Yoshikawa: Fusion Science and Tech. 52 (2007).

Simulation difficulties inherent in magnetron discharge

Blue lines: Equi-potential lines

Red lines: Magnetic flux lines

Green: Electrons' trajectories

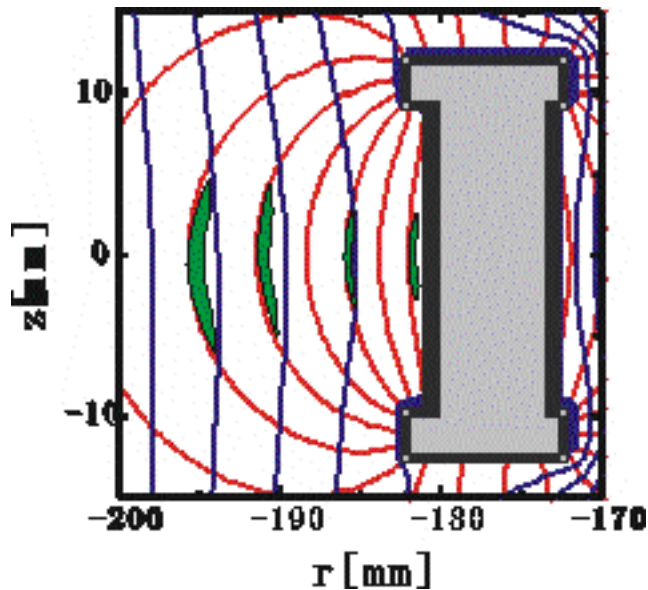

An electron is confined very well in 'banana' shape area by electro-magnetic field.

Length of trajectory from birth place to collision point (with a particle or electrode) can be very long, e.g. longer than 1000m.

→ Very long computational time

We would like to devise some ways to shorten the computational time.

Evolution of charge of macro particles

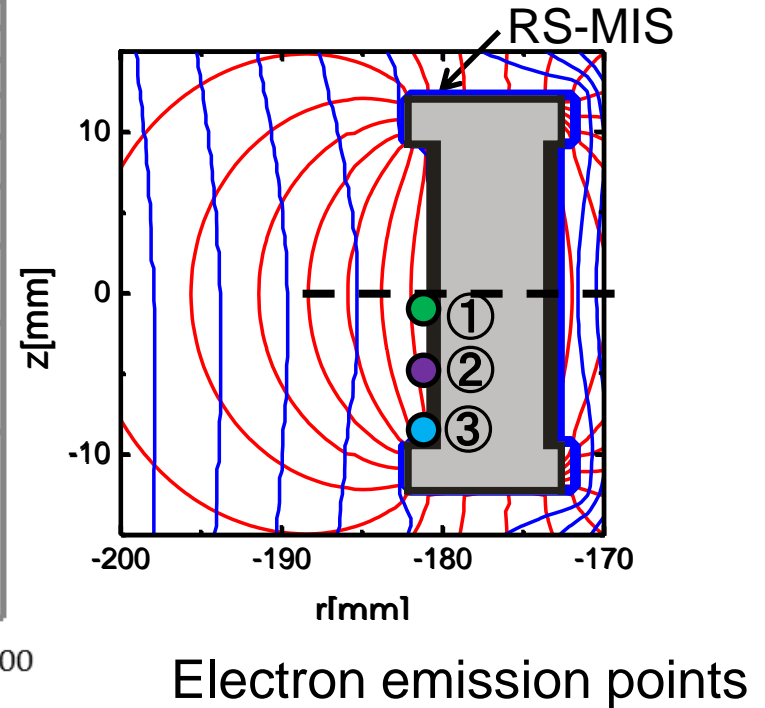
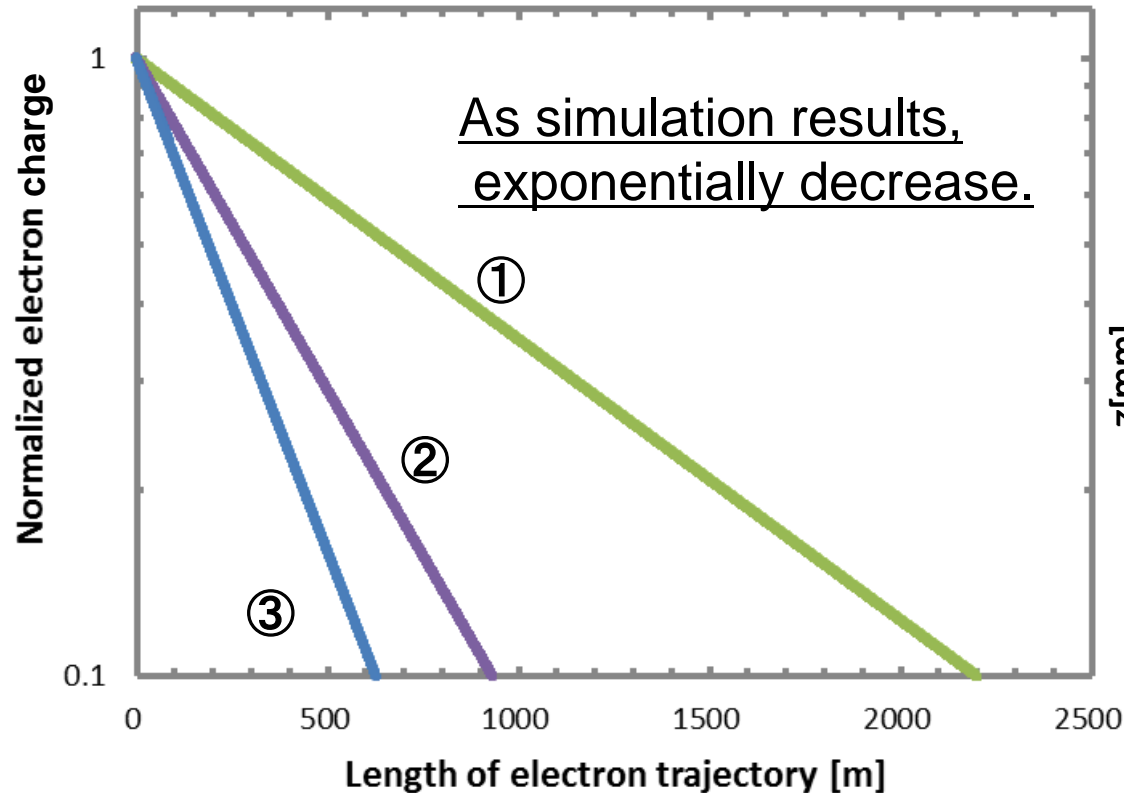

Theoretically, differential of charge of a macro particle (q) on trajectory length (x) should be proportional to the charge.

$$\frac{dq}{dx} = -Cq \quad C: \text{constant}$$

Therefore, extrapolation may be useful.

Suggestion of a calculating technique

x : trajectory length.

$q=q(x)$: charge of a macro particle.

1. Calculating a trajectory of a macro particle for a certain length $x=d$.
2. Calculating space-charge effect and produced particle charge by the macro particle.
3. Multiplying the space-charge effect and the produced charge by a factor of

$$\frac{q(0)}{q(0) - q(\mathbf{d})}$$

4. Considering these results as the results of $\mathbf{d} \rightarrow \infty$.

Choice of the length d

d should be longer than the size of the confinement area at least, because this method assumes round-trip motions.

Blue lines: Equi-potential lines
Red lines: Magnetic flux lines
Green: Electrons' trajectories

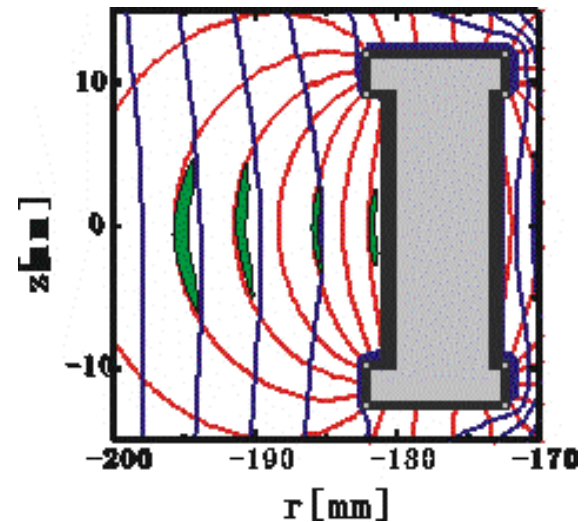

In following calculations, we use this extrapolation method from the results of $d=1$ m.

Dependence of ion current on electron current

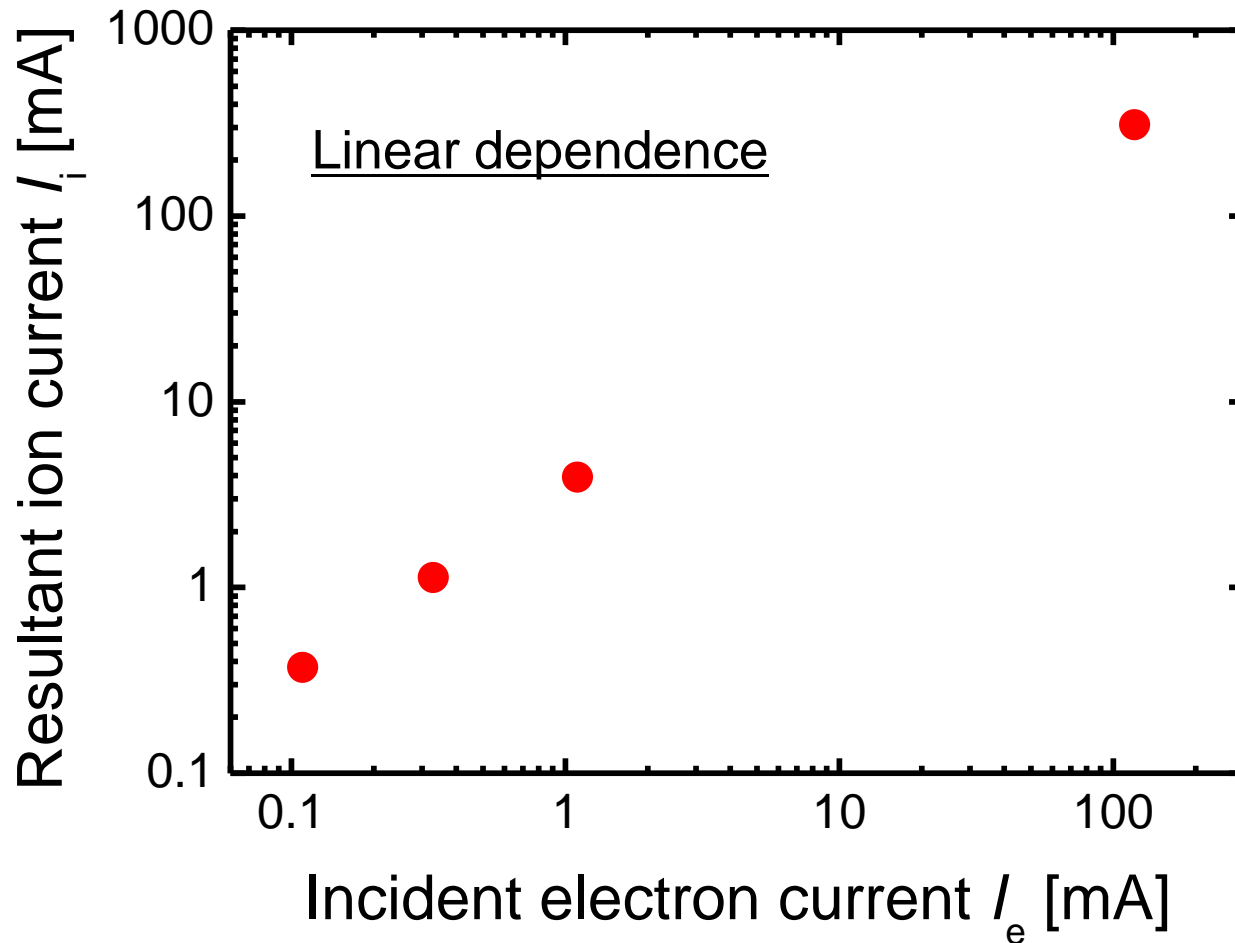

Significant saturation of I_i was not observed.

$I_e : I_i \sim 3:10$, independent on the I_e

Requirements for an electron emitter

	Tungsten dispenser cathode	Thoriated tungsten
Commercial availability	Available	Available
Emission current	~20A	~tens of A
Temperature	800~1200°C	~1800°C

The tungsten dispenser cathode can work in a pressure less than $10\mu\text{Pa}$, or in rare gases (He, Ar or Kr).

It is not clear if they can work in H_2 or D_2 gas, or not

→ Fundamental electron emission characteristics measurements are required.

Setup of the fundamental electron emission characteristics measurement of electron emitters



Tungsten dispenser cathode



Thoriated tungsten cathode

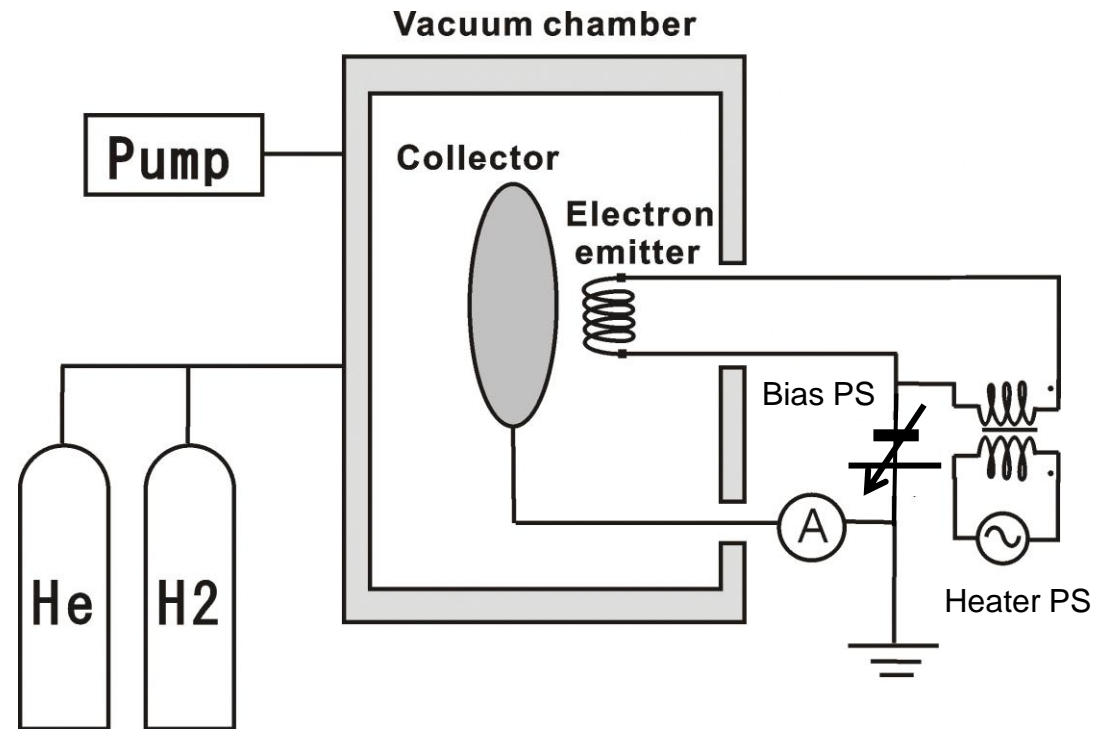

Preliminary experiments on the dispenser cathode

- cathode heating and current extraction in $100\mu\text{Pa}$ -

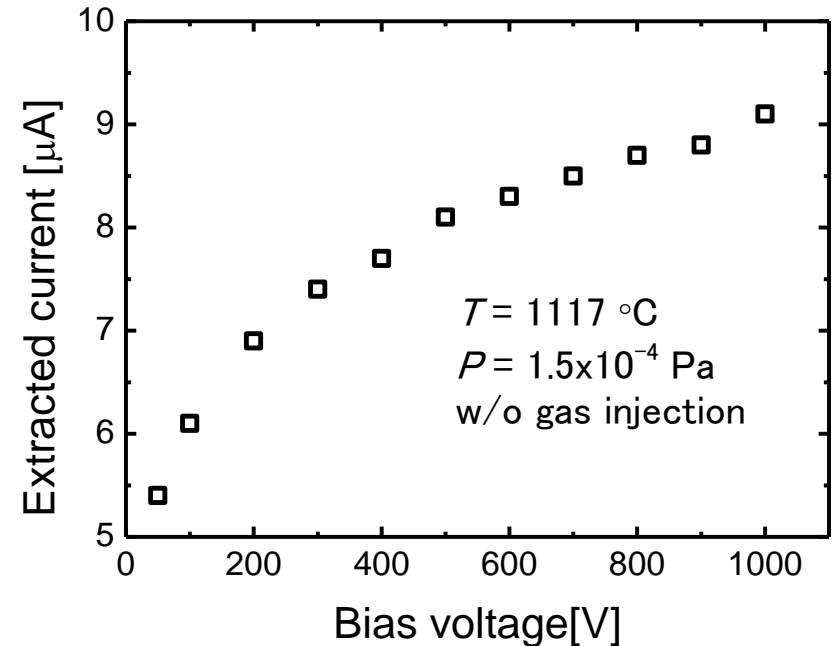
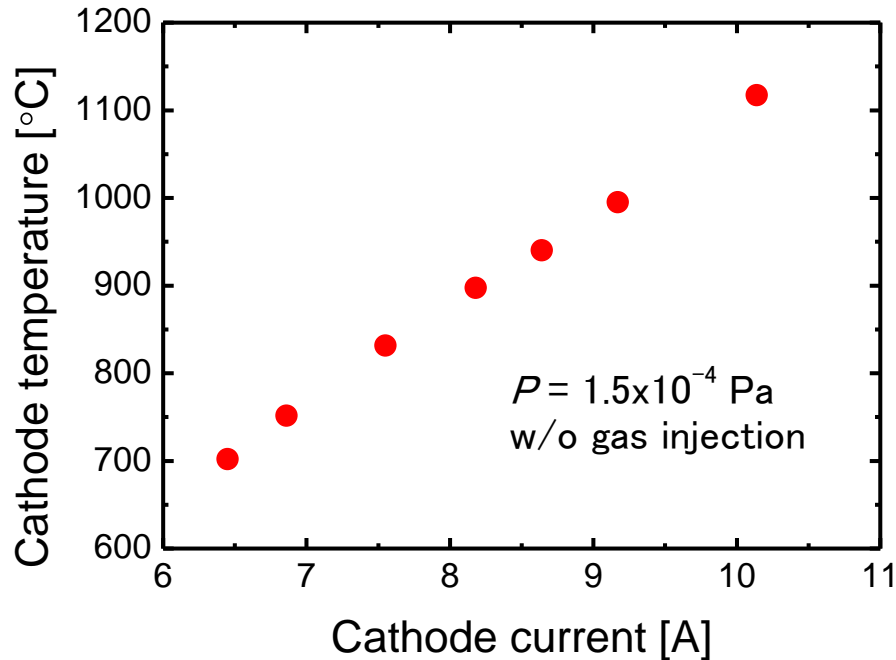

Extracted current was much small as expected.

..Operating pressure is too high and the cathode still not be activated, probably.

We are going to decrease gas pressure to $10^{-5} \sim 10^{-6} \text{ Pa}$.

Conclusions

In order to upgrade the RS-MIS IEC for high current operation, the application of thermal electron emitter is discussed.

- New numerical method for magnetron discharge was suggested, and it was found to be useful.
- Numerical simulation showed that flux of the macro particles of electrons decreased exponentially, as expected. It can make computing time shorter by extrapolation.
- Simulation also showed a linear increase of the RS-MIS ion current up to 120mA of incident electron current, and significant saturation was not observed. The ion current may be able to increase linearly up to 1A.

Future works

The fundamental electron emission characteristics of a tungsten dispenser cathode and a thoriaated tungsten cathode will be measured in vacuum, He and $H_2(D_2)$.

One of them will be attached to the RS-MIS instead of some of magnets, probably.